

CommBatt1

BDA Power and Battery Charger System
UL2524

CommBatt1F

BDA Power and Battery Charger System
UL2524, UL864, CAN/ULC-S527

Installation Guide



Rev. 031424



More than just power.™

Installing Company: _____ Service Rep. Name: _____

Address: _____ Phone #: _____

Overview:

Altronix CommBatt1(F) is an in-building power and battery backup solution for emergency response radio coverage system. Designed and engineered to meet NFPA 1225 codes providing integrators and consultants with a BDA power and backup option.

Specifications:

Agency Listings:

CommBatt1F:

- **UL864** Standard for Control Units and Accessories for Fire Alarm Systems.
- **UL2524** Standard for In-building 2-Way Emergency Radio Communication Enhancement Systems
- **CAN/ULC-S527 Fourth Edition, 2019,** Control Units for Fire Alarm Systems

CommBatt1:

- **UL2524** Standard for In-building 2-Way Emergency Radio Communication Enhancement Systems

Input:

- 115VAC-220VAC 50/60Hz, 2A.
- Input Fuse Rating: 5A/250V.

Output:

- 12VDC or 24VDC regulated output.
- UL2524 Specifications:
24V @ 5.5A total or 12V @ 9A total current.
- UL864/ULCS527 Specifications (**CommBatt1F only**):
24V: 3.5A standby, 6A Alarm
12V: 3.5A standby, 12A alarm.

Supervision (Form "C" contacts relays):

- **AC:** Failure/Brownout.
- **Battery:** Low Battery/Battery Presence/Battery fail.
- **Component Trouble:**
Critical Component Failure.
- **Ground Fault (CommBatt1F only)**
- **Charger Circuit Failure**
- **FACP Reporting**

Battery Backup:

- Built-in charger for sealed lead acid or gel type batteries.
- Up to four (4) 55AH batteries in series/parallel for 24V, One (1) to three (3) in parallel for 12V.
- 12AH option for UL864.
- Automatic switch over to stand-by battery when AC fails.
- Battery Fuse Rating: 20A/32V.
- Maximum charge current 3A for 12V and 2A for 24V.

Visual Indicators (See LED Diagnostics Table):

- AC High Side LED
- AC Low Side LED
- Heartbeat LED
- Battery LED
- Charger LED
- Ground Fault (CommBatt1F only) LED
- Component Fail LED

Enclosure Dimensions:

26" x 19.7" x 8" (660.5mm x 500mm x 203mm).

Stand-by Specifications:

UL864, CAN/ULC-S527 Compliance (CommBatt1F only):

Output	Stand-by/Alarm Current	Time
24V: 12VDC/55AH Battery (4 in series/parallel). <i>Total capacity 110AH.</i>	3.5A/6A @24V	24 hours + 30 minutes of alarm
12V: 12VDC/55AH Battery (2 in parallel). <i>Total capacity 110AH.</i>	3.5A/12A@12V	24 hours + 30 minutes of alarm

UL2524 Compliance (CommBatt1 and CommBatt1F):

Output	Stand-by/Alarm Current	Time
24V: 12VDC/55AH Battery (2 in series)	3.6A @ 24V	12 hours
12V: 12VDC/55AH Battery	3.6A @ 12V	12 hours
24V: 12VDC/55AH Batteries (4 in Series/ Parallel). <i>Total capacity 110AH.</i>	6A @ 24V	12 hours
12V: 12VDC/55AH Battery (2 in parallel) <i>Total capacity 110AH.</i>	7.3A @12V	12 hours
12V: 12VDC/55AH Battery (3 in parallel) <i>Total capacity 165AH.</i>	9A @12V	12 hours

For smaller batteries, 1.25 derating factor should be used when the load current is calculated.
See the table for popular battery sizes:

Output	12 hours backup	24 hours + 30 minutes of alarm
12AH (2 x 12AH batteries in series for 24V)	0.8A	0.15A
17AH (2 x 17AH batteries in series for 24V)	1.13A	0.3A
36AH (2 x 36AH batteries in series for 24V)	2.4A	0.9A

Power Supply Output Specifications:

WARNING: De-energize unit before switching!

Output VDC	Switch Position
12VDC	SW1 - ON (Fig. 2g)
24VDC	SW1 - OFF (Fig. 2g)

Installation Instructions:

Wiring methods shall be in accordance with the National Electrical Code/NFPA 70/NFPA 72/ANSI, Canadian Electrical Code, Part 1 and with all local codes and authorities having jurisdiction.

Product is intended for indoor use only.

1. Attach wall mounting brackets to the enclosure as shown on Fig. 1 and Fig. 1a.
2. Mount unit in the desired location. Mark and predrill holes in the wall to line up with mounting hardware included with the product; level and secure. Mark the position of the lower two holes. Drill the lower holes and install two fasteners. Install the two lower screws and make sure to tighten all screws (*Enclosure Dimensions*, pg. 12).
Secure enclosure to earth ground using ground stud inside.
3. Set the unit to the desired DC output voltage by setting SW1 (Fig. 2b, pg. 6) to the appropriate position prior to energizing (*Power Supply Output Specification Chart*, pg. 3).
4. Connect AC power (115VAC-220VAC 50/60Hz) to the terminals marked [L, N] (Fig. 2a). Green "AC" LED on power supply board will turn on (Fig. 2c). This light can be seen through the window on the door of the enclosure.
5. Battery Interface Module is factory connected to power supply board. Connect batteries individually to terminals [Positive] and [Negative] Battery 1 though Battery 4 of either "12V Section" or "24V Section", depending on the application. See Fig. 3, pg. 7 for detailed explanation.
See *Stand-by Specifications*, pg. 2 for compatible batteries.
6. Measure output voltage before connecting devices. This helps avoiding potential damage.
Connect devices to the terminals marked [+ DC -] (Fig. 2, pg. 6).
When servicing the unit, AC mains should be removed and battery disconnected.
7. Connect Altronix Annunciator to AC FAIL, Low Bat ,Charger Fail, Component Fail and, optionally, Ground Fault (CommBatt1F only, Fig. 2a, pg. 6) supervisory relay outputs. If end of line resistor is used it has to be connected between EOL and corresponding [Com] terminals with field wiring connected between NC and NO terminals.
8. **FACP Relay Connection:** Connect UL Listed EOL resistor recommended for specific FACP to terminals [EOL] and [C]. Connect FACP EOL supervised input to terminals [NO] and [NC]. This connection is needed if the Annunciator FACP terminals are not used. The trouble condition will be reported in case of any of the failures in Step 7.
9. Please ensure that the cover is secured with the provided lock.

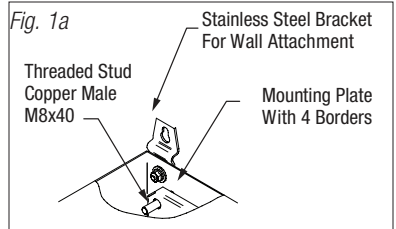
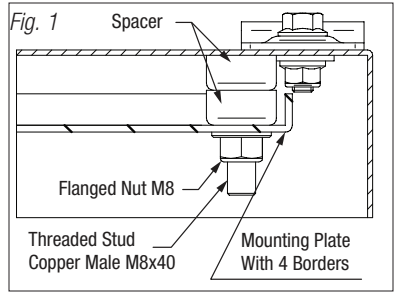

Wiring:

For wiring entering and exiting the enclosure UL Listed/Recognized Type 4X/IP68 rated hardware is to be employed. See Fig. 4, pg. 8 for recommended location of openings. Use appropriate tools recommended by the manufacturer to drill the enclosure. Make sure hole diameters correspond to those recommended by the specific hardware manufacturer. Follow hardware manufacturer's instructions in order to maintain Type 4/4X rating.

It is recommended to use separate entry points for non power-limited wiring (AC input, Batteries and DC output) and power-limited low voltage wiring (trouble relays contacts). 0.25" spacing between power-limited and non power-limited circuits is to be provided. Use 14 AWG or larger for all power connections (AC, Battery, DC Output). For other connections 18-22AWG wire can be used.

LED Diagnostics:

Ground Fault* (CommBatt1F only) (Fig. 2d, pg. 6)

LED	Power Supply Status
Solid	No ground fault detected
0.5 sec. Blink	Ground fault

Component Failure (Fig. 2d, pg. 6)

LED	Power Supply Status
Solid	No component failure detected
0.5 sec. Blink	Critical Component Failure

Battery (Fig. 2d, pg. 6)

LED	Power Supply Status
ON (Solid)	Battery OK
0.5 sec. Blink	Battery is missing or discharged below 70% capacity

(AC) Low Side (Fig. 2d, pg. 6)

LED	Power Supply Status
ON (Solid)	AC is on
0.5 sec. Blink	AC Brownout or failure

Charger (Fig. 2d, pg. 6)

LED	Power Supply Status
Solid	Charger is OK
0.5 sec. Blink	Charger trouble

All LEDs Together, Except for Heartbeat (critical failure indications) (Fig. 2d, pg. 6)

LED	Power Supply Status
2 Blinks	Lower power disconnect. AC is anticipated
3 Blinks	Wrong output voltage detected during startup
4 Blinks	Wrong voltage from the battery detected
5 Blinks	Failure of the power supply and battery, total shutdown

Blue (Heartbeat) (Fig. 2d, pg. 6)

LED	Power Supply Status
Solid or Extinguished	Processor failure
0.5 second blink	Processor is operating normally, no RS485 communication enabled.
2 blinks and pause	No ANC1BBU annunciator is connected. RS485 communication is enabled.
3 blinks and pause	Loss of communication with one of connected ANC1BBU annunciators.
4 blinks and pause	First time connected, no Annunciators assigned.
5 blinks and pause	RS485 communication is running normally.

*Model CommBatt1 does not have a Ground Fault indicating LED.

Terminal Identification (Power Supply Board):

Terminal Legend	Function/Description
L, G, N (Fig. 2a, pg. 6)	Connect 115-220VAC 50/60Hz to these terminals: L to hot, N to neutral. Do not use the [G] terminal. Non power-limited circuit.
+ RS485 – (Fig. 2e, pg. 6)	RS485 communication link. Optional. If communication board is installed, at least one ANC1BBU must be connected. Unplug communication board if RS485 is not used.
+ AUX – (Fig. 2e, pg. 6)	12 or 24 V AUX power for connection to Altronix model ANC1BBU Annunciator. Power-limited, 0.6A maximum. Voltage corresponds to the output voltage selected.
G Fault NO NC C EOL* (Fig. 2f, pg. 6)	Indicates Ground Fault (CommBatt1F only) on DC output or AUX output. 330 Ohm maximum impedance. Relay Contacts are Form "C". Contact rating 0.4A/28VDC. 0.6 power factor.
FACP NO NC C EOL* (Fig. 2g, pg. 6)	Terminals used to report trouble condition to FACP. Must be EOL supervised. Any of the troubles (AC, Bat, Charger, Component, Ground, Communication failure) are reported by this relay. Contact rating 0.4A/28VDC. 0.6 power factor.
Charger NO NC C EOL* (Fig. 2h, pg. 6)	Indicates loss of battery charging power, e.g. connect to audible device or alarm panel. Relay Contacts are Form "C". Contact rating 0.4A/28VDC. 0.6 power factor.
Component NO NC C EOL* (Fig. 2i, pg. 6)	Indicates critical component failure. Relay Contacts are Form "C". Contact rating 0.4A/28VDC. 0.6 power factor.
Battery NO NC C EOL* (Fig. 2g, pg. 6)	Indicates low or missing battery condition, e.g. connect to alarm panel. Relay Contacts are Form "C". Contact rating 0.4A/28VDC. 0.6 power factor. A removed battery is reported within 100 seconds. Battery reconnection is reported within 100 seconds. Low battery is reported when battery capacity falls below 30%.
AC NO NC C EOL* (Fig. 2k, pg. 6)	Indicates loss of AC power, e.g. connect to audible device or alarm panel. Relay Contacts are Form "C". Contact rating 0.4A/28VDC. 0.6 power factor. AC or brownout fail is reported within 1 minute of event. If delay for 1-3 hours is required, the FACP should be programmed to delay the signal to off-premises devices.
– BAT + (Fig. 2l, pg. 6)	Stand-by battery connections. Factory connected to Battery Interface Module. Maximum charge current 3A @12V or 2A @ 24V. Non power-limited circuit.
+ OUT – (Fig. 2m, pg. 6)	12 or 24VDC Output. Non power-limited Class B circuit. Use UL listed end of line relay to supervise.

* EOL supervised input is to be employed. Use End of Line resistor called by the device connected.

Fig. 2

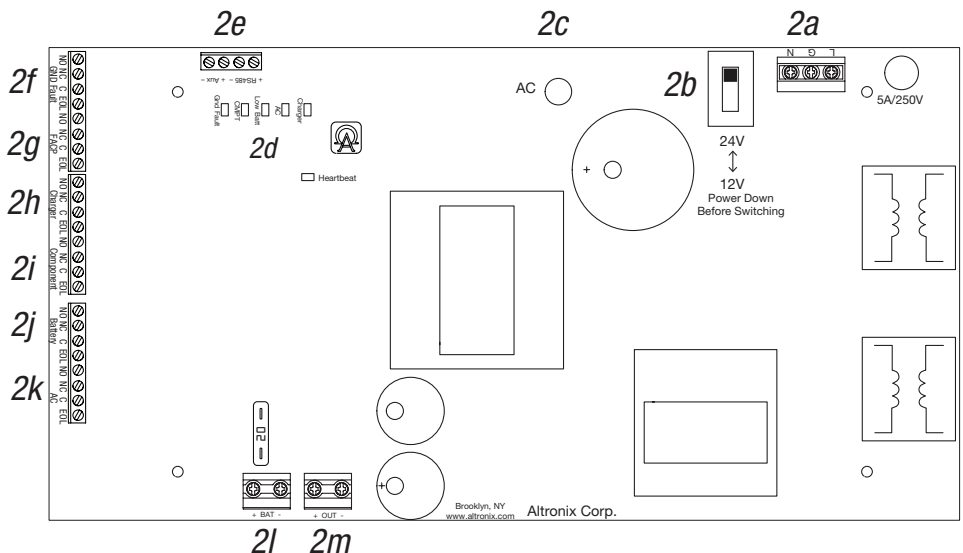

Terminal Identification (Battery Interface Module):

Terminal Legend	Function/Description
+ -	Factory connected to power supply board.
12V Section Parallel Connection <i>Battery1 through Battery4</i> [Positive] [Negative]	Connect 1-4 12V batteries for 12V output. Up to 4 batteries can be connected to achieve more capacity.
24V Section Series/Parallel Connection <i>Battery1 through Battery4</i> [Positive] [Negative]	Facilitates series/parallel connection of 12V batteries for 24V backup. Either 2 or 4 batteries need to be used. If only 2 batteries are used, connect to terminals [Battery1] and [Battery3]

Fig. 3

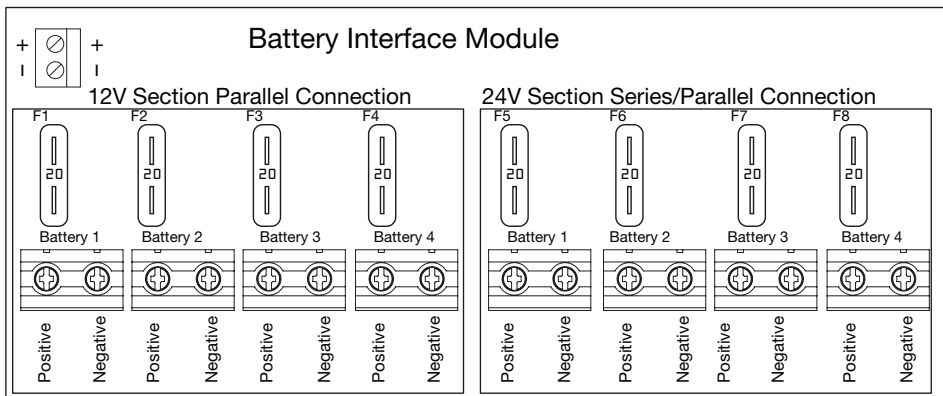

Maintenance:

Unit should be tested at least once a year for the proper operation as follows:

- Fuses:** Replace fuses with the same type and rating only:
20A/32V for Battery Interface and the power supply battery fuse.
- Output Voltage Test:** Under normal load conditions, the DC output voltage should be checked for proper voltage level (*refer to Power Supply Voltage Output Specifications chart*).
- Supervision Test:** Disconnect backup battery(ies). Make sure that LED and relays indicate missing battery and Charger OK. Reconnect batteries.
Disconnect AC. Make sure that LED and supervisory relays indicate AC loss.
Detection/restoration of the fault condition may take up to 150 seconds.
- Battery Test:** Under normal load conditions check that the battery is fully charged, check specified voltage both at the battery terminal and at the board terminals marked [+ BAT -] to ensure that there is no break in the battery connection wires.
- Note:** Maximum charging current under discharge is 4A.
- Note:** Expected battery life is 5 years, however it is recommended changing batteries in 4 years or less if needed.

Fig. 4 - CommBatt1(F) Wiring Diagram

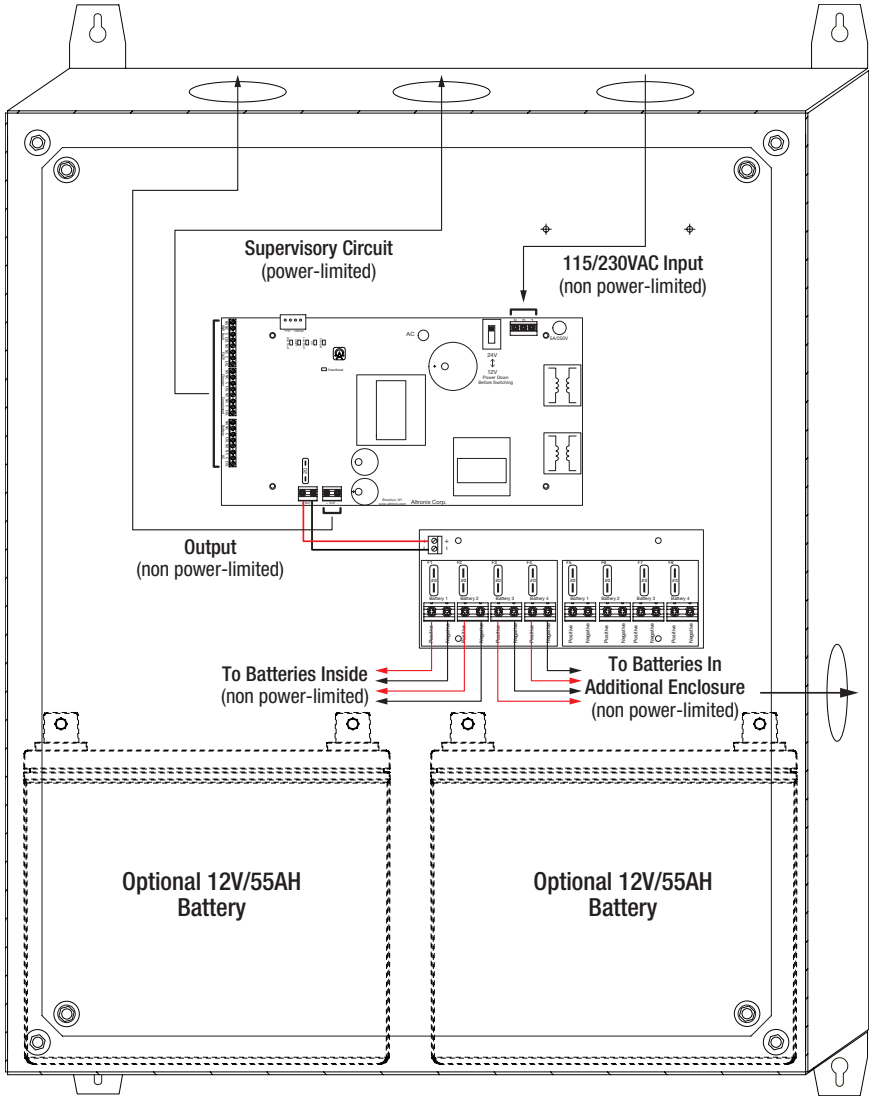

Two (2) 12V/55AH batteries can fit in the CommBatt1(F) enclosure.
If additional batteries are needed, separate enclosure is to be employed. Altronix part Number: **CommBattEXP**

Fig. 5 - CommBatt1(F) with Optional UL Listed CommBattEXP Expansion Battery Enclosure

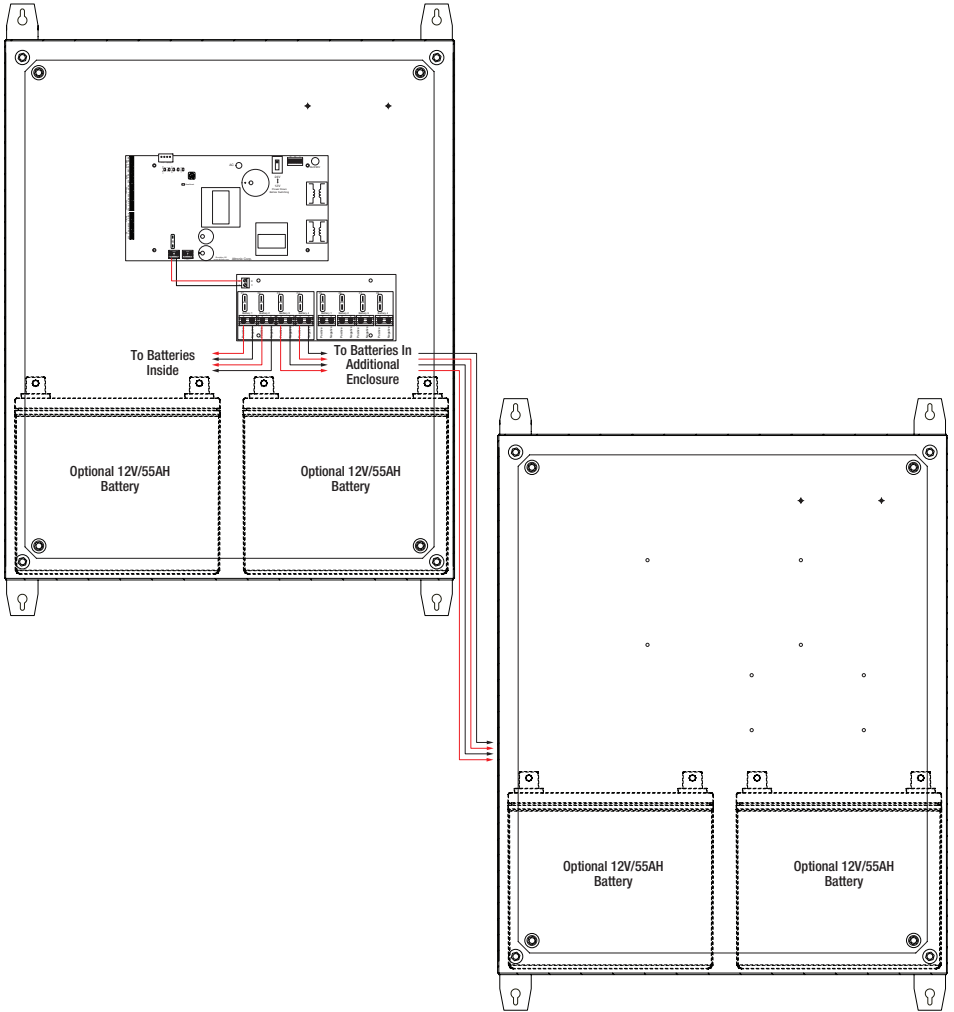

Altronix CommBatt ANC1BBU Annunciator Connections to the Power Supply:

Hardwire Connection:

1. Connect 10K end of line resistors to the terminals marked [EOL] and corresponding “C” terminals.
Connect wiring from the ANC1BBU or FACP to “NC” and “NO” terminals.
Altronix EOL model no. ALEOL10 is supplied with Annunciator.
For FACP connection use End Of Line resistor recommended by FACP manufacturer.
2. Connect [+ AUX -] to [Power+] and [Power -] of the ANC1BBU Annunciator.
Connect terminals as follows:
 - [AC Fail] connects to [AC Fail] input
 - [Low Bat] connects to [Low Battery] input
 - [CHRG Fail] connects to [Charger Fail] input
 - [COMP Fail] connects to [Component Fail] input
 - [G Fault] connects to [Ground Fault (CommBatt1F only)] input.See ANC1BBU Installation Guide Doc No. IANC1BBU for more information.

RS485 Connection:

For distances up to 1,500 ft. RS485 communication link can be used instead of hardwiring CommBatt1(F) Annunciator. All the trouble conditions will be transmitted through twisted 18/2 pair. Up to seven (7) Annunciators can be connected to one CommBatt1(F) unit for local trouble indication as long as the total length of wire links between units does not exceed 1,500 ft. Plug in RS485 Communication module before powering up the system. If RS485 module is plugged in and Annunciator is not connected, CommBatt1(F) will report trouble to FACP. Observe polarity. Connect [+ RS485 -] terminals of CommBatt to [+ RS485 -] terminals of ANC1BBU. See ANC1BBU Installation Guide Doc No. IANC1BBU for Address setting and other information. 100 Ohm AT1 termination resistor (supplied) must be installed on the last communicator in the chain. See *Fig. 6, pg. 10*. See LED Diagnostics for RS485 trouble condition indication.

Fig. 6

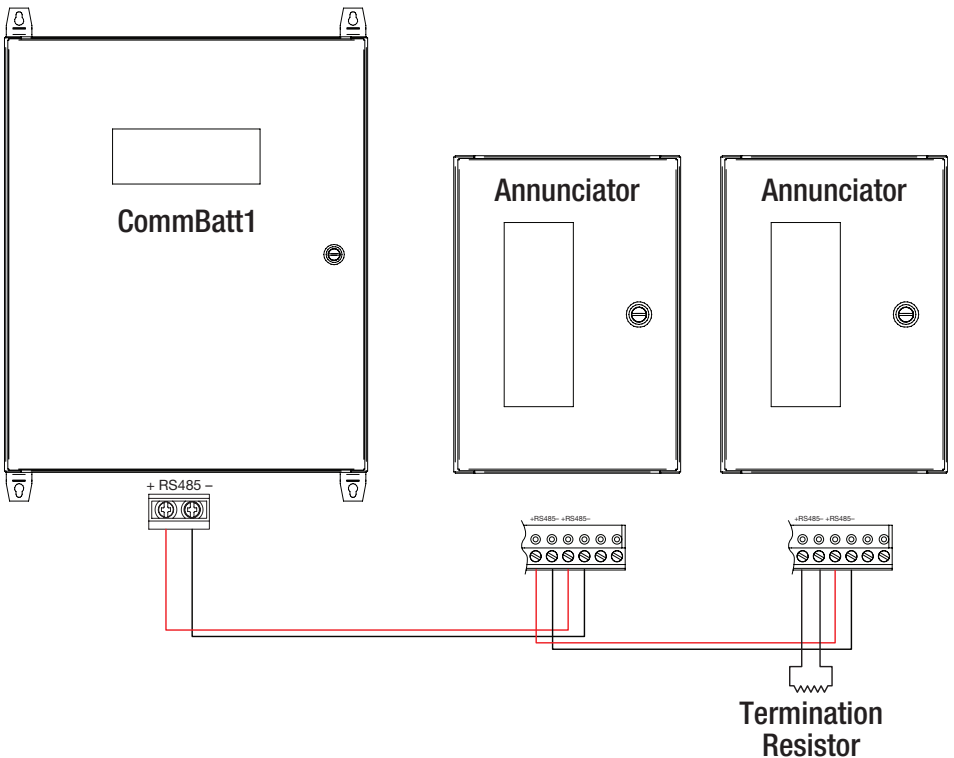

Notes:

Enclosure Dimensions (H x W x D approximate):

26" x 19.7" x 8" (660.5mm x 500mm x 203mm)

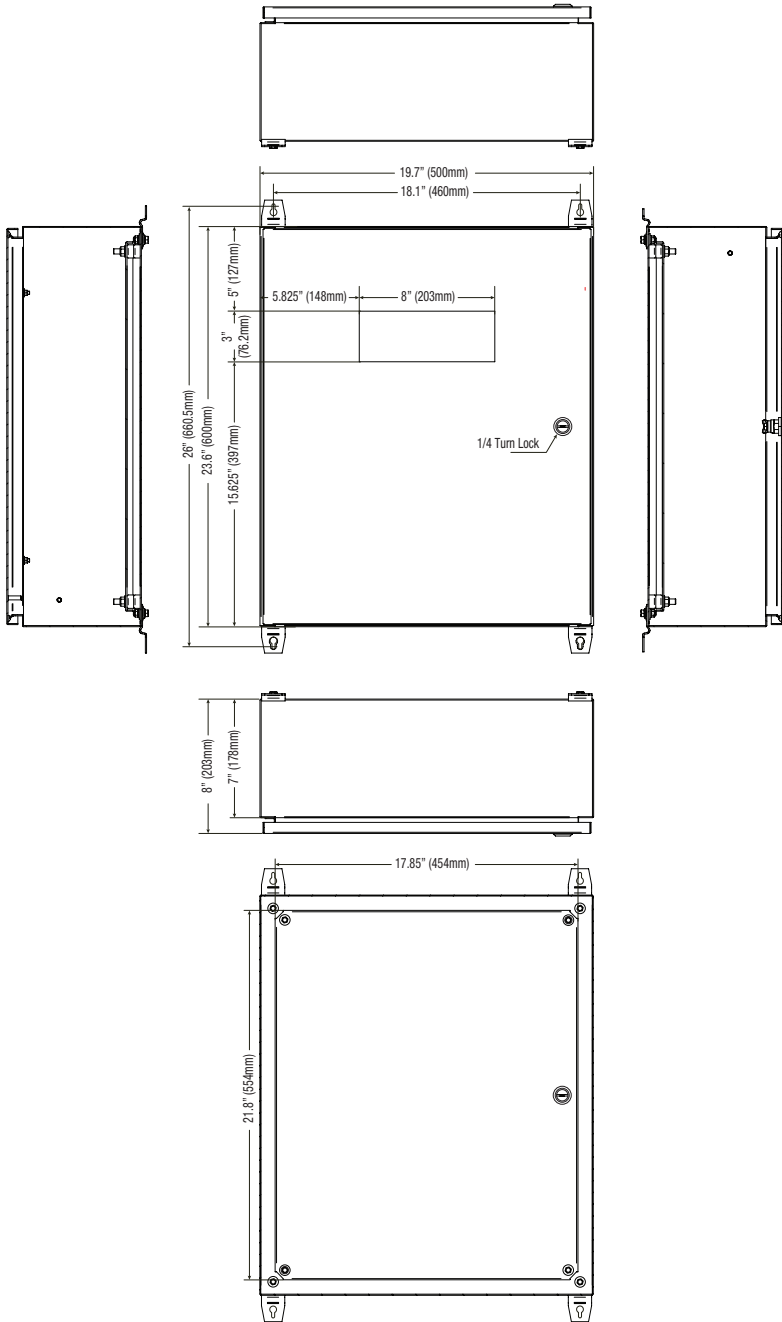

Altronix is not responsible for any typographical errors.

140 58th Street, Brooklyn, New York 11220 USA | phone: 718-567-8181 | fax: 718-567-9056
website: www.altronix.com | e-mail: info@altronix.com | Lifetime Warranty
ICommBatt1(F) E29X

